

| | | | | |
|---|--------------------------------|--|------------|-----------|
| Schellekens <small>PROFESSIONALS IN ZONWERING</small> Platinaweerf 10 Postbus 83 6640 AB Beuningen KvK: Nijmegen 10017058 T: 024 6778000 F: 024 6778001 E: info@schellekens.com W: www.schellekens.com Mailadres tekenkamer: tekenaar@schellekens.com | Status : | Project : | Datum : | Revisie : |
| | SCHELLEKENS & SCHELLEKENS b.v. | Verticale screen Type V75REL | 22-10-2013 | A |
| | DEFINITIEF | Product : | Schaal : | B |
| | Paraaf voor akkoord: | Elektrisch bediend Hirschmannstekker op de kast | 1:3 | C |
| | | Werknummer : | Maat : | D |
| | Artikel nummer : | mm | E | |
| | Getekend : | A3 | F | |
| | EVB | Tekening nr. : | G | |
| | | 001 | | |

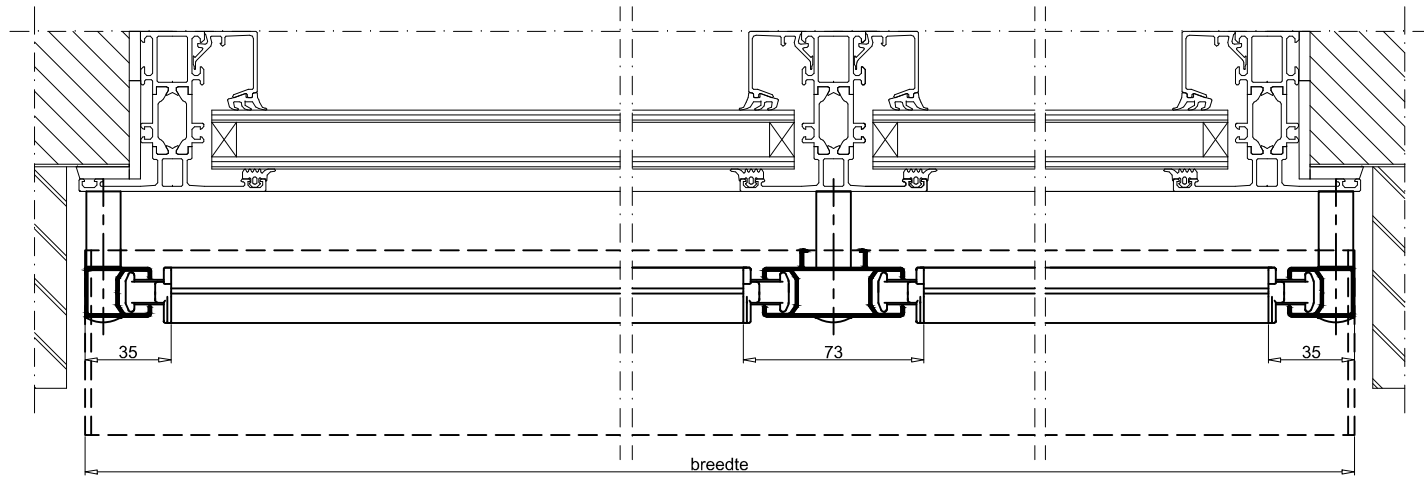

| | | | | |
|---|--|---------------------------------|--|----------------|
| Schellekens <small>PROFESSIONALS IN ZONWERING</small> Platinaweg 10 Postbus 83 6640 AB Beuningen KvK: Nijmegen 10017058 T: 024 6778000 F: 024 6778001 E: info@schellekens.com W: www.schellekens.com Mailadres tekenkamer: tekenaar@schellekens.com | Status : | Project : | Datum : | Revisie : |
| | SCHELLEKENS & SCHELLEKENS b.v. | Verticale screen Type V75REL | 22-10-2013 | A |
| | DEFINITIEF | Product : | Schaal : | B |
| | Alle rechten zijn uitdrukkelijk voorbehouden aan Schellekens & Schellekens BV. Vermenging/vulging of mededeling aan derden, in welke vorm dan ook, is zonder schriftelijke toestemming van Schellekens & Schellekens BV niet geoorloofd. | Paraaf voor akkoord: | Elektrisch bediend Hirschmannstekker achter de kast | 1:3 |
| | Paraf voor akkoord: | Werknummer : | Maat : | D |
| | | Artikel nummer : | mm | E |
| | | Getekend : | | F |
| | | EVB | Formaat : | G |
| | | | A3 | Tekening nr. : |
| | | | | 002 |

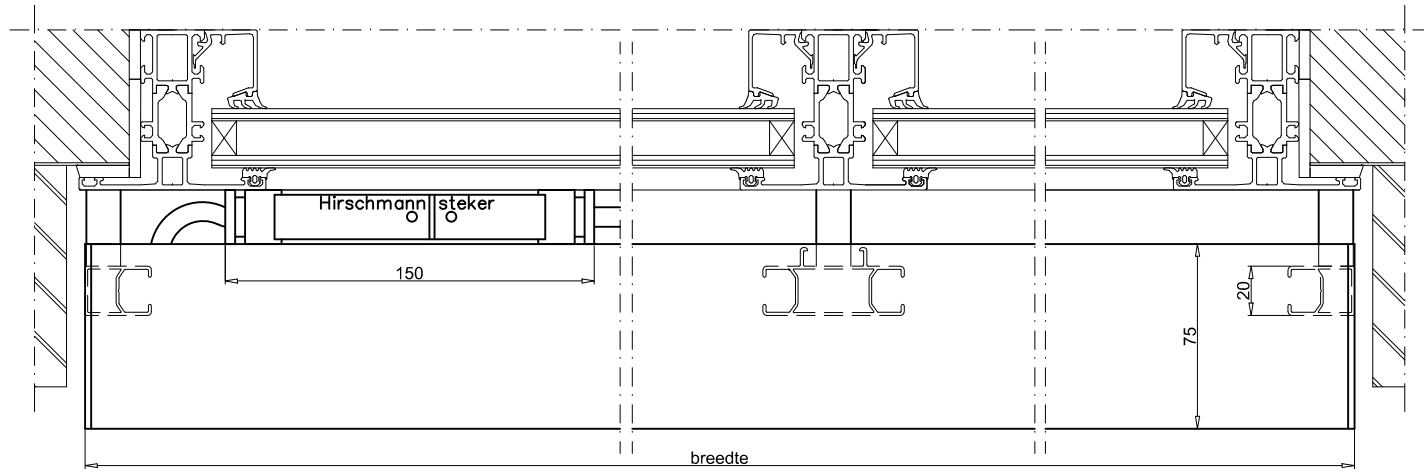
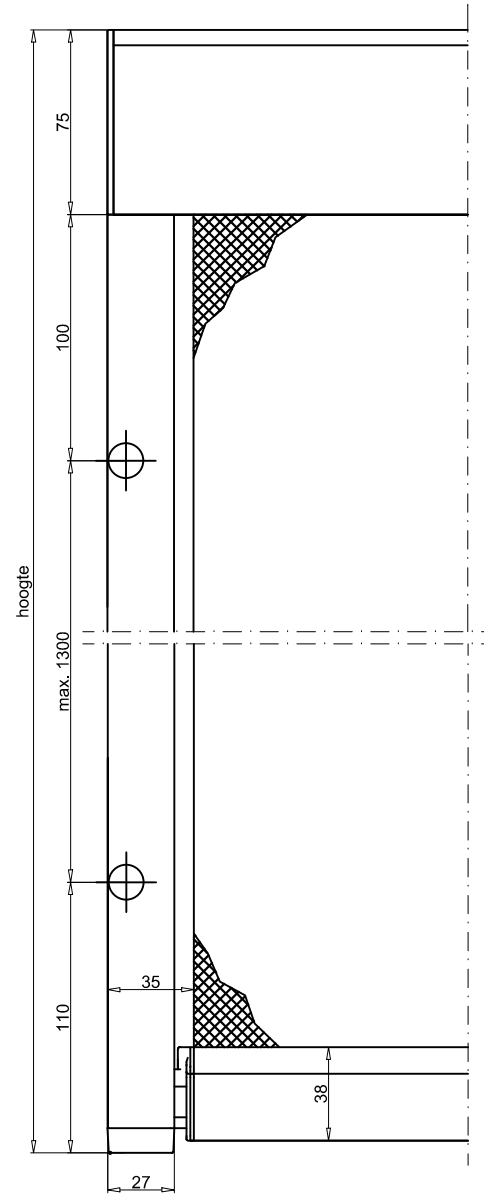
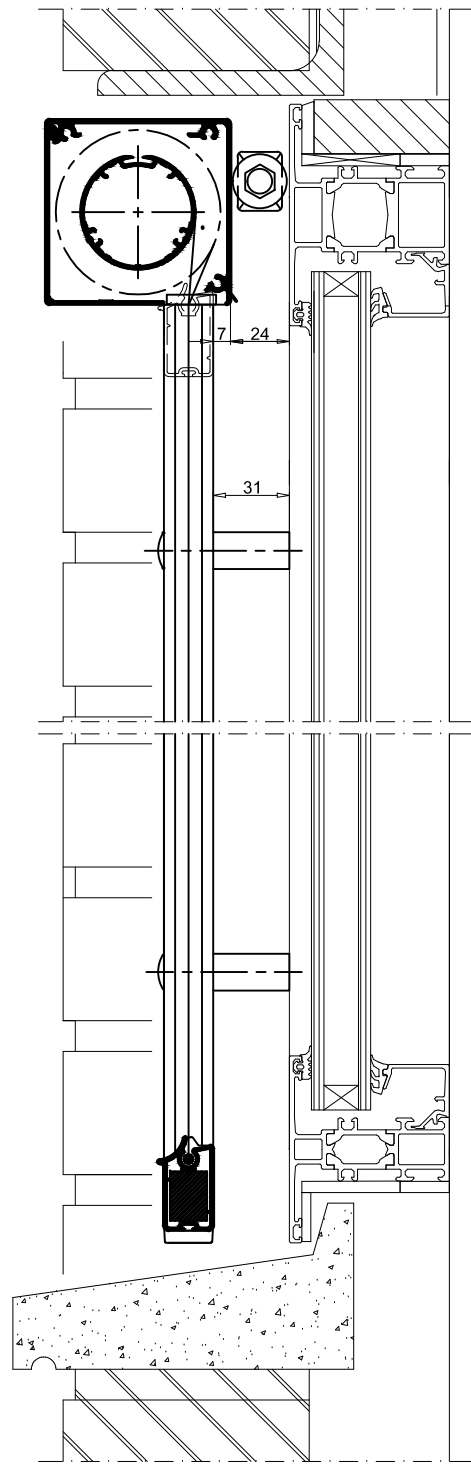
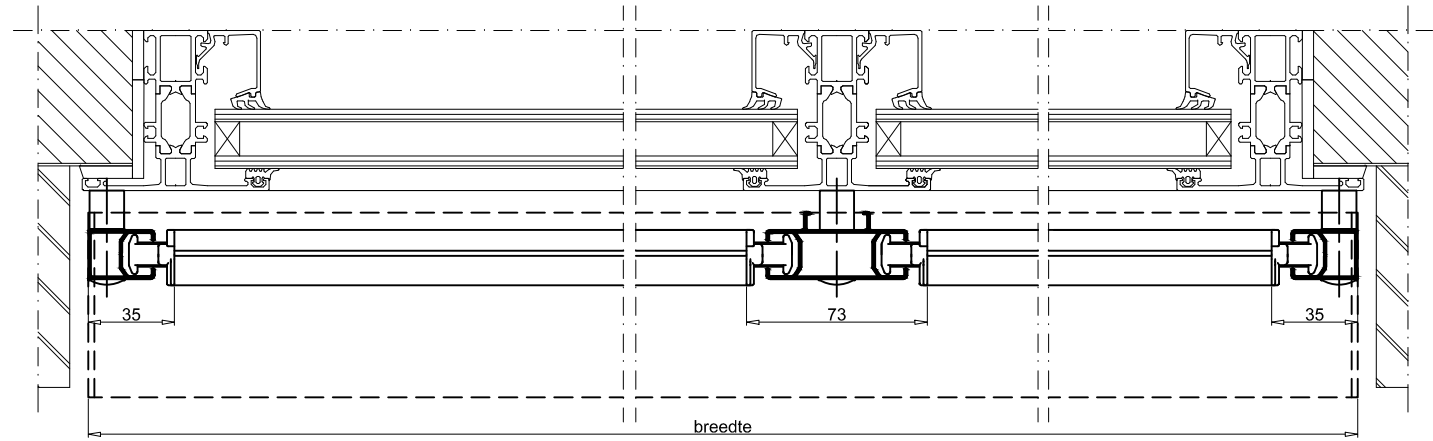
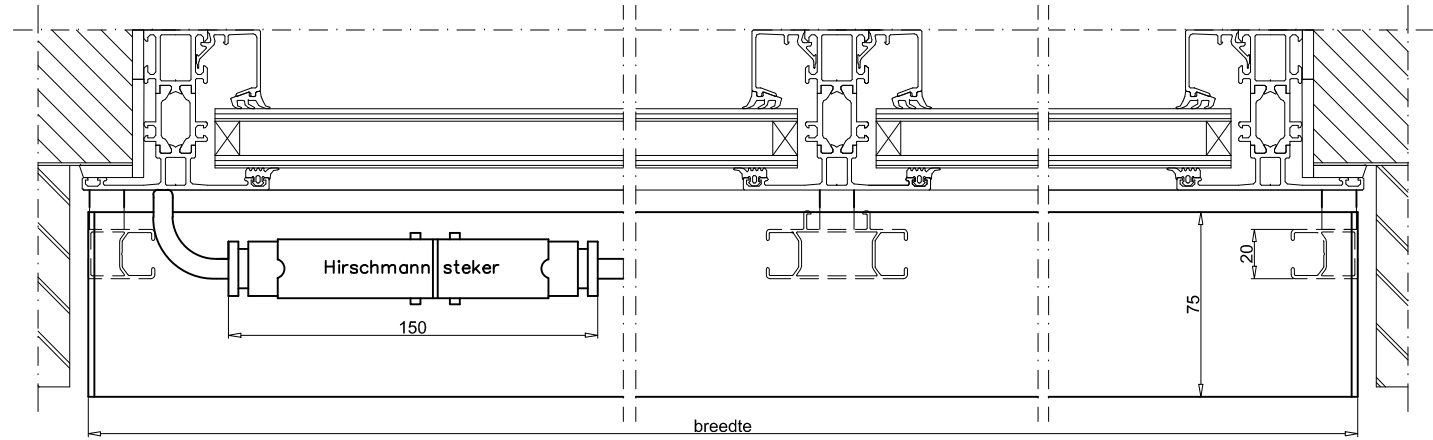
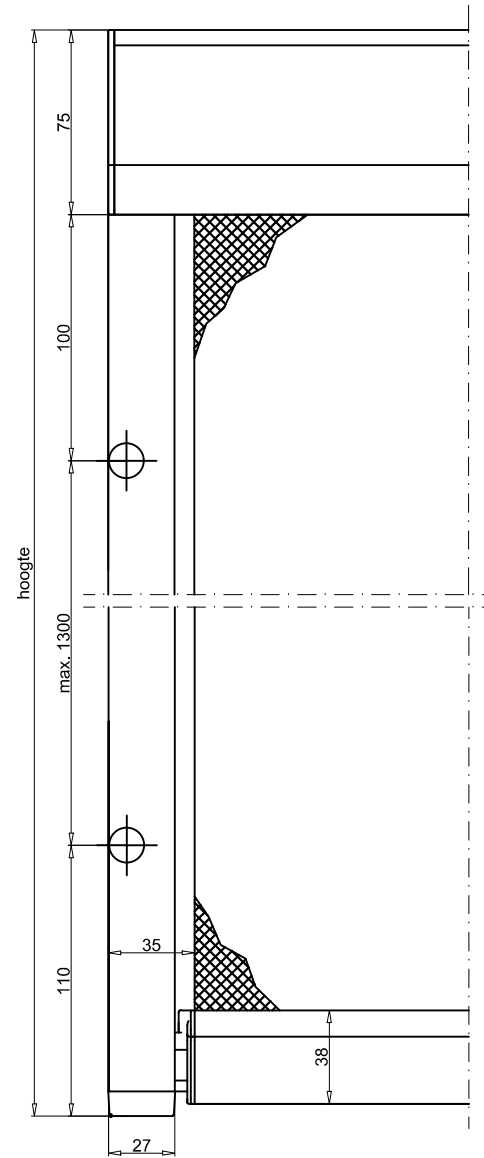
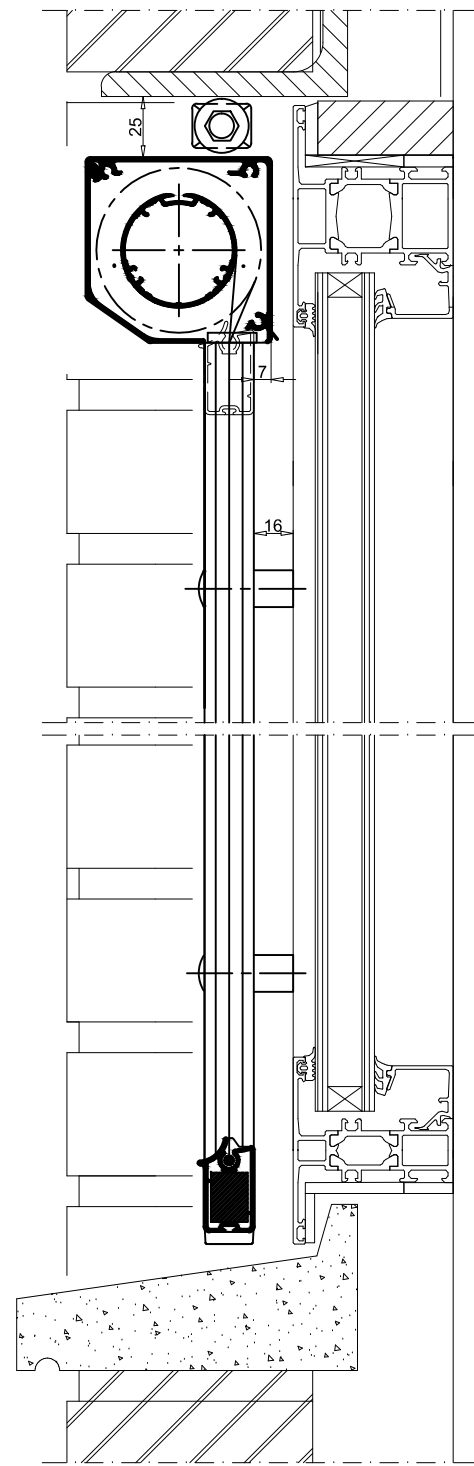

| | | | | |
|---|--------------------------------|--|------------|-----------|
| Schellekens <small>PROFESSIONALS IN ZONWERING</small> Platinaweerf 10 Postbus 83 6640 AB Beuningen KvK: Nijmegen 10017058 T: 024 6778000 F: 024 6778001 E: info@schellekens.com W: www.schellekens.com Mailadres tekenkamer: tekenaar@schellekens.com | Status : | Project : | Datum : | Revisie : |
| | SCHELLEKENS & SCHELLEKENS b.v. | Verticale screen Type V75SEL | 22-10-2013 | A |
| | DEFINITIEF | Product : | Schaal : | B |
| | Paraaf voor akkoord: | Elektrisch bediend Hirschmannstekker op de kast | 1:3 | C |
| | Paraf: | Werknummer : | Maat : | D |
| | Artikel nummer : | mm | E | |
| | Getekend : | EVB | F | |
| | Formaat : | A3 | G | |
| | Tekening nr. : | 001 | | |

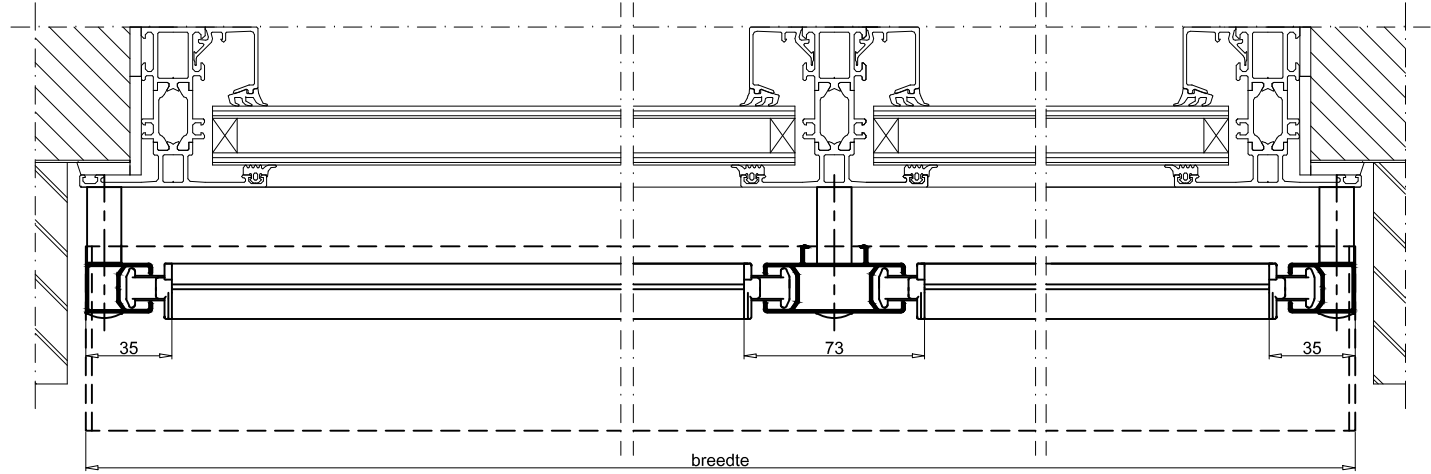
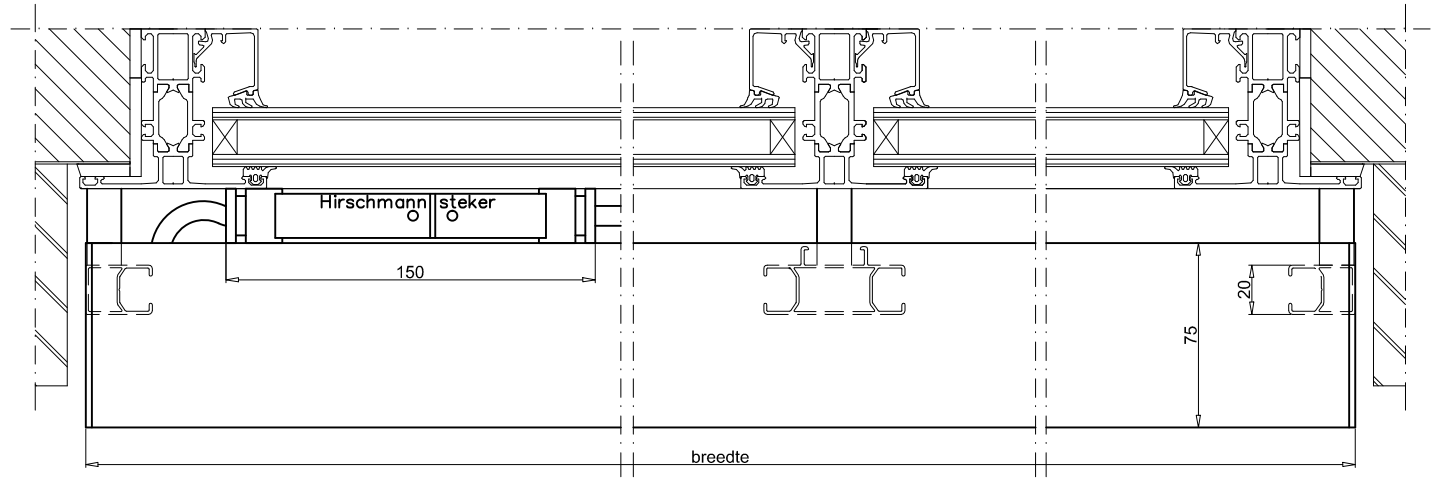
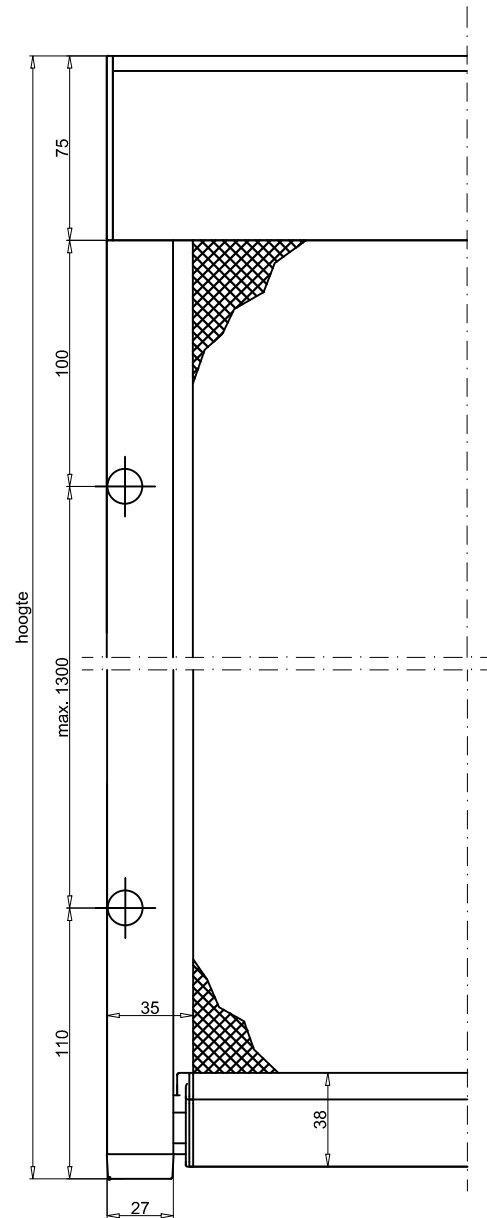
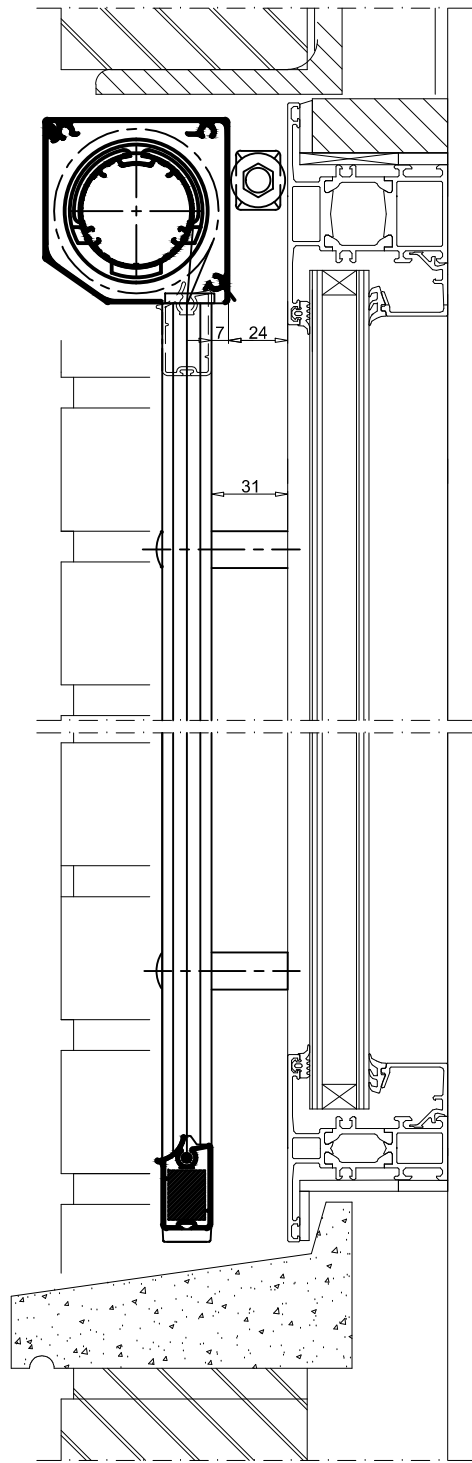

| | | | | |
|---|---|--|----------------|-----------|
| Schellekens <small>PROFESSIONALS IN ZONWERING</small> Platinaweerf 10 Postbus 83 6640 AB Beuningen KvK: Nijmegen 10017058 T: 024 6778000 F: 024 6778001 E: info@schellekens.com W: www.schellekens.com Mailadres tekenkamer: tekenaar@schellekens.com | Status : | Project : | Datum : | Revisie : |
| | SCHELLEKENS & SCHELLEKENS b.v. DEFINITIEF | Verticale screen Type V75SEL | 22-10-2013 | A |
| | | Product : | Schaal : | B |
| | | Elektrisch bediend Hirschmannstekker achter de kast | 1:3 | C |
| | | Paraaf voor akkoord: | Maat : | D |
| | | mm | E | |
| | | Getekend : | F | |
| | | EVB | G | |
| | | Formaat : | Tekening nr. : | |
| | | A3 | 002 | |